



Empowering your business, one transaction at a time.

Innovative payment solutions delivered with a personal touch.

Accept payment in-person or online with our innovative terminal solutions. Whether you need a stationary, wireless, mobile, or virtual terminal, a payment gateway, or software integration, ECS is the right choice for you.

Diverse Solutions for every scenario.



Lending

Lending your way to provide you with the instant capital you need.



ACH

Completely electronic, ACH transactions are efficient and low-cost.



ATM

Connect to all major ATM networks.



Merchant Cash Advance

Access the assets your business deserves.



Banking

Access our affordable rates and award-winning merchant services team.



Credit & Debit

Diverse range of credit and debit card processing solutions.



Remote Deposit Capture

No need to go to the bank to cash payment checks.



High-Risk

We're built to handle complex merchants, regardless of your industry.

To find out more [click here](#)



Mini

Quick Start Guide

Kurzanleitung / Instructions de démarrage / Guía de inicio rápido
Guida introduttiva / Snelstartgids

clover.com/help/mini-3



Included

Inclus
Im Lieferumfang
Se incluye
Incluso
Inclusief



Select regions

Certaines régions
Ausgewählte Regionen
Algunas regiones
Per alcune zone
Sommige regio's

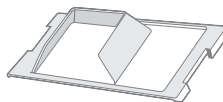
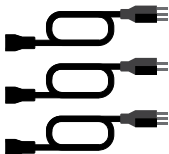

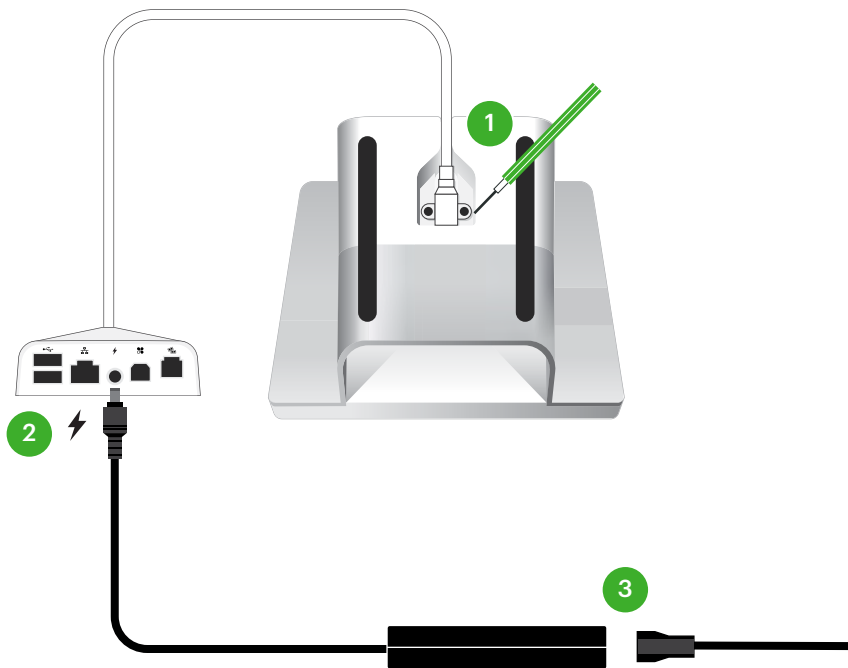

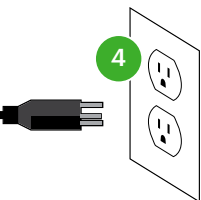
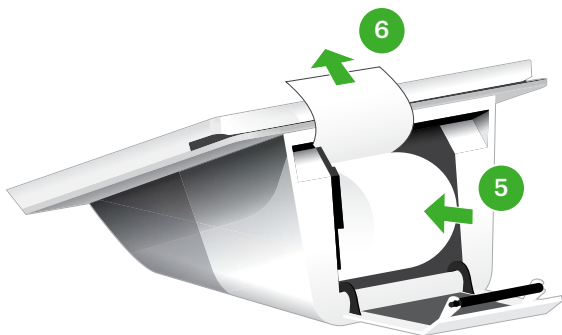

Plug in last, to a grounded AC power outlet.

Brancher en dernier sur une prise de courant alternatif (CA) mise à la terre.

Zuletzt einstecken.

Enchufe al último.

Collegare per ultimo.

Sluit als laatste aan.

FCC Part 15

This device complies with Part 15 of the FCC Rules. Operation is subject to the following two conditions: (1) This device may not cause harmful interference, (2) This device must accept any interference received, including interference that may cause undesired operation.

FCC Part 15 Class B-specific

Note: This equipment has been tested and found to comply with the limits for a Class B digital device, pursuant to part 15 of the FCC Rules. These limits are designed to provide reasonable protection against harmful interference in a residential installation. This equipment generates, uses and can radiate radio frequency energy and, if not installed and used in accordance with the instructions, may cause harmful interference to radio communications. However, there is no guarantee that interference will not occur in a particular installation. If this equipment does cause harmful interference to radio or television reception, which can be determined by turning the equipment off and on, the user is encouraged to try to correct the interference by one or more of the following measures:

- Reorient or relocate the receiving antenna.
- Increase the separation between the equipment and receiver.
- Connect the equipment into an outlet on a circuit different from that to which the receiver is connected.
- Consult the dealer or an experienced radio/TV technician for help.

FCC Warning

Changes or modifications not expressly approved by the party responsible for compliance could void the user's authority to operate the equipment.

FCC exposure limit compliance statement (SAR statement)

This equipment complies with radio frequency (RF) exposure limits adopted by the Federal Communications Commission for an uncontrolled environment. This equipment should be installed and operated with minimum distance 20 cm between the radiator & your body.

Innovation, Science and Economic Development Canada (ISED) statement: CAN ICES-3 (B)/NMB-3(B)

This device complies with ISED's license-exempt RSSs. Operation is subject to the following two conditions:

- (1) this device may not cause interference, and
- (2) this device must accept any interference, including interference that may cause undesired operation of the device.

Le présent appareil est conforme aux CNR d'Industrie Canada applicables aux appareils radio exempts de licence. L'exploitation est autorisée aux deux conditions suivantes:

- (1) l'appareil ne doit pas produire de brouillage, et
- (2) l'utilisateur de l'appareil doit accepter tout brouillage radioélectrique subi, même si le brouillage est susceptible d'en compromettre le fonctionnement.

The device could automatically discontinue transmission in case of absence of information to transmit, or operational failure. Note that this is not intended to prohibit transmission of control or signaling information or the use of repetitive codes where required by the technology.

- The device for operation in the band 5150–5250 MHz is only for indoor use to reduce the potential for harmful interference to co-channel mobile satellite systems;
- The maximum antenna gain permitted for devices in the bands 5250–5350 MHz and 5470–5725 MHz shall comply with the e.i.r.p. limit; and
- The maximum antenna gain permitted for devices in the band 5725–5825 MHz shall comply with the e.i.r.p. limits specified for point-to-point and non point-to-point operation as appropriate.

In addition, high-power radars are allocated as primary users (i.e. priority users) of the bands 5250–5350 MHz and 5650–5850 MHz and that these radars could cause interference and/or damage to LE-LAN devices.

L'appareil pourrait automatiquement interrompre la transmission s'il n'y a aucune information à transmettre ou en cas de panne fonctionnelle. À noter que l'objectif de cette disposi-

tion n'est pas d'empêcher la transmission d'informations de contrôle ou de signalisation, ou encore l'utilisation de codes répétitifs exigés par la technique.

- L'appareil fonctionnant dans la bande comprise entre 5 150 et 5 250 MHz est uniquement réservé à une utilisation en intérieur, afin de réduire le risque d'interférences nocives aux systèmes mobiles par satellite utilisant le même canal;
- Le gain d'antenne maximum autorisé pour les appareils fonctionnant dans les bandes comprises entre 5 250 et 5 350 MHz, et entre 5 470 et 5 725 MHz, doit se conformer à la limite de p.i.r.e.; et
- Le gain d'antenne maximum autorisé pour les appareils fonctionnant dans la bande comprise entre 5 725 et 5 825 MHz doit se conformer aux limites de p.i.r.e. spécifiées pour l'exploitation point à point et non point à point, selon le cas.

De plus, les utilisateurs de radars de haute puissance sont désignés comme utilisateurs principaux (c.-à-d. comme utilisateurs prioritaires) des bandes comprises entre 5 250 et 5 350 MHz, et entre 5 650 et 5 850 MHz, et ces radars pourraient causer des interférences et/ou des dommages aux appareils LAN-EL.

This equipment complies with IC RSS-102 RF exposure limits set forth for an uncontrolled environment. This equipment should be installed and operated with minimum distance 20 cm between the radiator & your body.

Cet équipement est conforme aux limites d'exposition aux rayonnements IC établies pour un environnement non contrôlé. Cet équipement doit être installé et utilisé avec un minimum de 20 cm de distance entre la source de rayonnement et votre corps.

CE RF Exposure Compliance

This device meets the EU requirements (1999/519/EC) and the International Commission on Non-Ionizing Radiation Protection (ICNIRP) on the limitation of exposure of the general public to electromagnetic fields by way of health protection.

This device is restricted to indoor use only when operating in the 5150 to 5350 MHz frequency range.

IMPORTANT for UK Power Adapter Cord

If the available socket outlet is not suitable for the plug supplied with this equipment, it should be cut off and an appropriate three pin plug fitted. With alternative plugs on approved 3 amp fuse must be fitted in the plug or adaptor or in the main fuse box.

The plug severed from the mains lead must be destroyed, as a plug with bared flexible cords is hazardous if engaged in a live socket outlet. In the event of replacing the plug fuse, use a 3 amp fuse approved by ASTA to BS 1362, i.e. carries the  mark. Always replace the fuse cover, never use plugs with the fuse cover omitted.

WARNING — THIS APPLIANCE MUST BE EARTHED.

The wires in this mains lead are coloured in accordance with the following code:

Green-and-Yellow = Earth Blue = Neutral Brown = Live

As the colour of the wiring in the mains lead of this appliance may not correspond with the coloured markings identifying the terminals in your plug, proceed as follows:

- The wire which is coloured Green-and-Yellow must be connected to the terminal in the plug which is marked with the letter “E”, or by the earth symbol or coloured Green-and-Yellow.
- The wire which is coloured Blue must be connected to the terminal which is marked with the letter “N” or coloured Black or Blue.
- The wire which is coloured Brown must be connected to the terminal which is marked with the letter “L” or coloured Red or Brown.

Argentina

 Este producto utiliza para su funcionamiento una fuente de alimentación, modelo FSP040-RHBN3 marca Clover con las siguientes características técnicas: Entrada: AC 100-240 V, 50-60 Hz, 1,5 A, Cl. I; Salida: DC 12 V, 3,33 A, que ha sido certificada para su utilización en el mercado argentino.

 Conectar una fuente diferente a la provista podría ocasionar un incendio o choque eléctrico. No utilice una fuente diferente a la provista con el equipo.

EU Declaration of Conformity

Hereby, Clover Network, LLC declares that the radio equipment type, C305 is in compliance with Directive 2014/53/EU. The full text of the EU declaration of conformity is available at the following internet address:

eu.clover.com/eu-compliance

The frequency band and the maximum transmitted power in EU are listed below:

2400MHz – 2483.5MHz: 20 dBm (EIRP)

5150MHz – 5250MHz: 23 dBm (EIRP)

5250MHz – 5350MHz: 23 dBm (EIRP)

5470MHz – 5725MHz: 23 dBm (EIRP)

LTE Band 1: 23dBm (conducted)

LTE Band 3: 23dBm (conducted)

LTE Band 7: 23dBm (conducted)

LTE Band 8: 23dBm (conducted)

LTE Band 20: 23dBm (conducted)

NFC (13.56MHz): -1.43 dB μ A/m (@10m)

Restrictions in

AT/BE/BG/CZ/DK/EE/FR/DE/IS/IE/IT/EL/ES/CY/LV/LI/LT/LU/HU/MT/NL/NO/PL/PT/RO/SI/SK/TR/FI/SE/CH/UK(NI)/HR/UK. 5150MHz-5350MHz is for indoor use only.

Caution: Exposure to Radio Frequency Radiation

This equipment complies with EU radiation exposure limits set forth for an uncontrolled environment. This equipment should be installed and operated with minimum distance 20cm between the radiator & your body.

Clover Mini 3

Model Number: C305

Patent

clover.com/patents

Clover Network, LLC
415 N Mathilda Ave
Sunnyvale, CA 94085, USA

EU Importer: Marketplace
Merchant Solutions Ltd
Unit 9, Richview Office Park
Clonskeagh, Dublin 14, Ireland



Waste Electrical and Electronic Equipment-WEEE

NOTE: This product is covered electronic equipment under the European Union's Waste from Electrical and Electronic Equipment ("WEEE") Directive (2012/19/EU). The WEEE Directive requires that covered equipment be collected and managed separately from typical household waste in all EU member states. Please follow the guidance of your local environmental authority or ask the shop where you purchased the product for collection or recycling options.